

07/2018

Mod: ICE70A-R2(42G)

Production code: CB640A/E HC



Diamond
catering equipment

SCHEMA ELETTRICO / ELECTRIC DIAGRAM

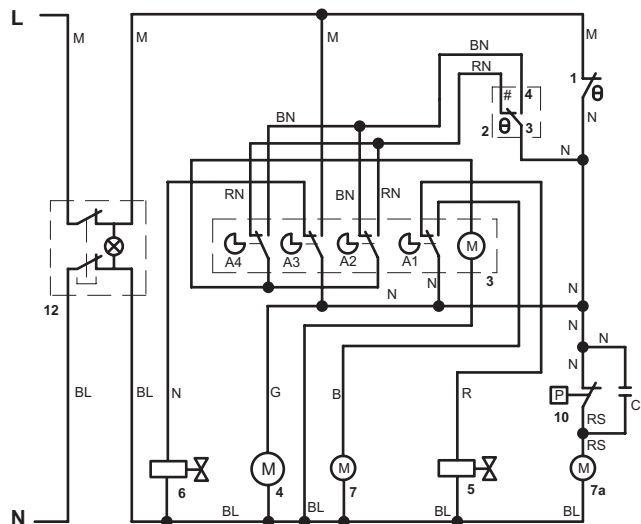

VERSIONE AD ARIA / AIR COOLED

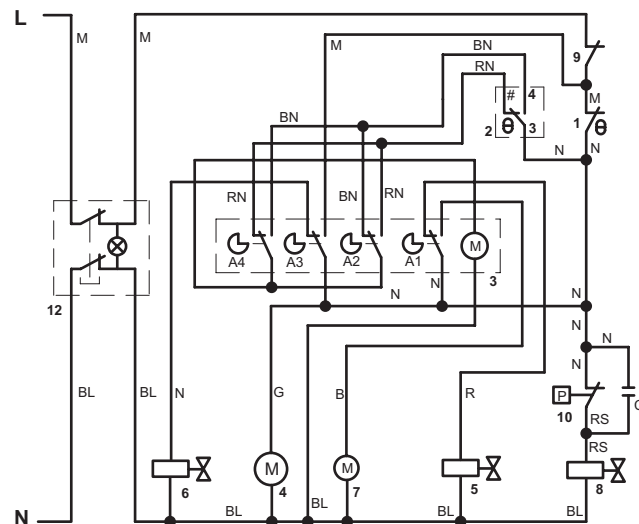

VERSIONE AD ACQUA / WATER COOLED

1. TERMOSTATO CONTENITORE BIN THERMOSTAT	5. ELETTROVALVOLA GAS CALDO HOT GAS VALVE	8. ELETTROVALVOLA INGRESSO ACQUA PER CONDENSATORE WATER INLET VALVE FOR CONDENSER	B = BIANCO / WHITE BL = BLU / BLUE BN = BIANCONERO / WHITE-BLACK G = GRIGIO / GREY M = MARRONE / BROWN N = NERO / BLACK R = ROSSO / RED RN = ROSSO-NERO / RED-BLACK RS = ROSA / PINK
2. TERMOSTATO EVAPORATORE EVAPORATOR THERMOSTAT	6. ELETTROVALVOLA INGRESSO ACQUA PER EVAPORATORE WATER INLET VALVE FOR EVAPORATOR	9. TERMOSTATO DI SICUREZZA SAFETY THERMOSTAT	
3. TEMPORIZZATORE TIMER	7. POMPA PUMP	10. PRESSOSTATO PRESSURE SWITCH	
4. COMPRESSORE COMPRESSOR	7a. MOTOVENTILATORE FAN MOTOR	12. INTERRUPTORE LUMINOSO SWITCH ON-OFF (GREEN LIGHT)	
			# 6 = RANCO K59 # 2 = RANCO K22